

# EFH Series

Pompe Alta Pressione - High Pressure Pumps

70/310

1000 RPM

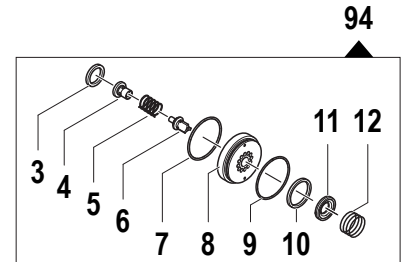
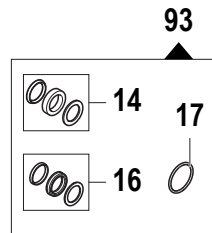
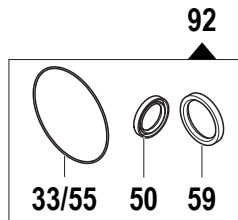
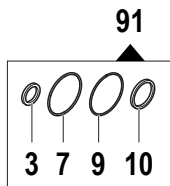
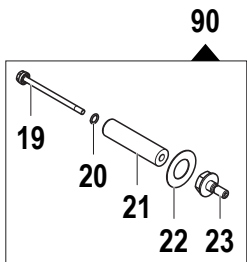
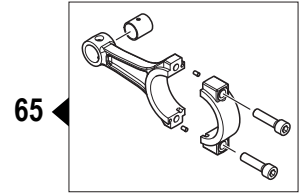
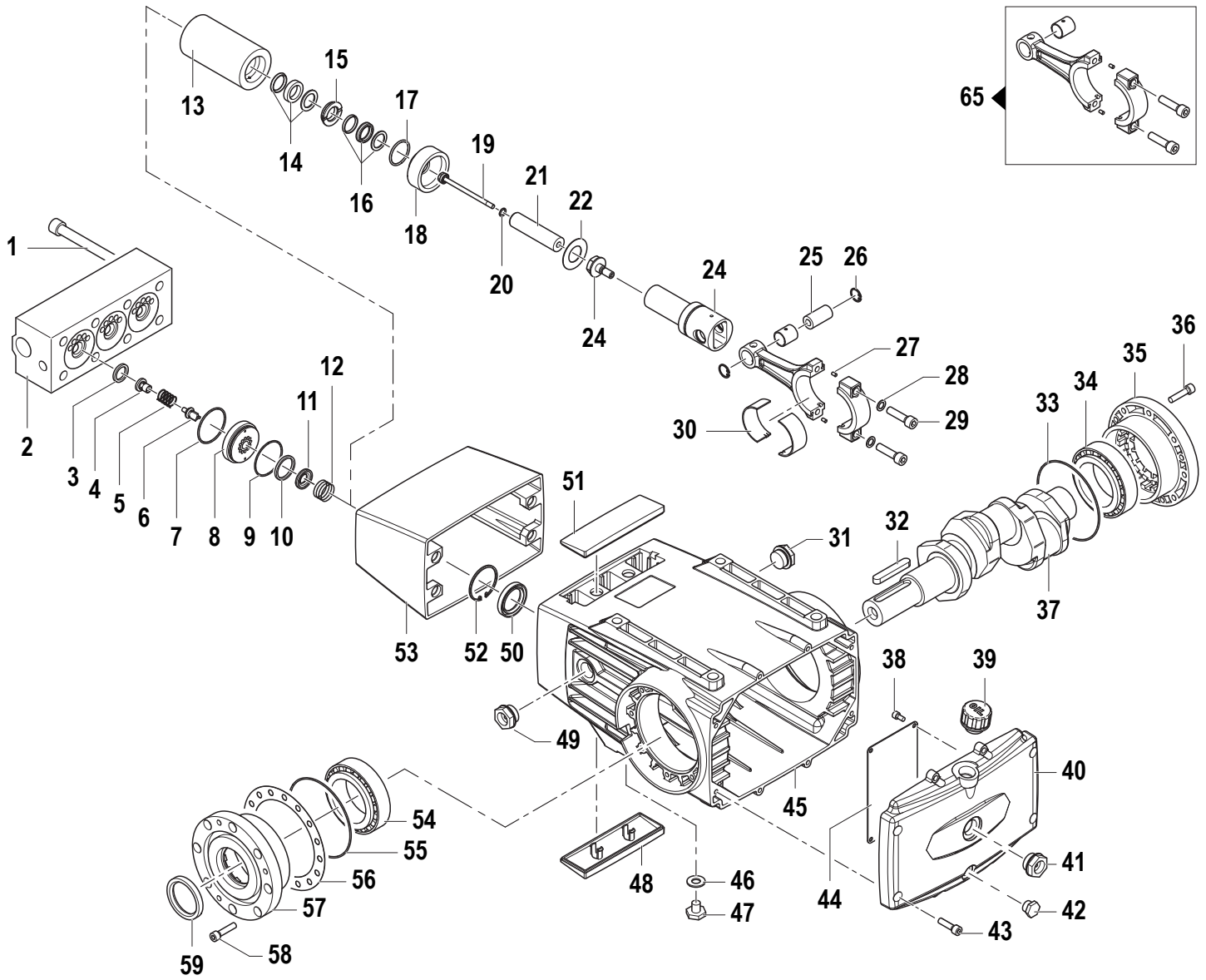

N°	Cod.	Descrizione	Description	Note	Q.ty	Model
1	3609 0306	Vite	Screw	M14x250	8	
2	3218 0521	Testata Pompa	Pump Manifold		1	
3	0019 0173	Anello Tenuta	Sealing Ring		3	
4	1205 0070	Gabbia Valvola	Valve Cage		3	
5	1802 0309	Molla	Spring		3	
6	3604 0052	Valvola Mandata	Delivery Valve		3	
7	1210 0219	Guarnizione OR	O-Ring	Ø2,62x52,07	3	
8	3009 0223	Sede Valvola Aspirazione Mandata	Suction / Delivery Valve Seat		3	
9	1210 0649	Guarnizione OR	O-Ring	Ø1,78x50,52	3	
10	0019 0172	Anello Tenuta	Sealing Ring		3	
11	3604 0058	Valvola Aspirazione Mandata	Suction / Delivery Valve		3	
12	1802 0347	Molla	Spring		3	
13	0009 0785	Anello Porta Guarnizione Anteriore	Front Packing Retainer	Ø22	3	
14	1241 0075	Guarnizione Tenuta	Packing	Ø22	3	
15	0009 0282	Anello Porta Guarnizione	Packing Retainer	Ø22	3	
16	1241 0088	Guarnizione Tenuta	Packing	Ø22	3	
17	1210 0032	Guarnizione OR	O-Ring	Ø2,62x34,6	3	
18	0009 0786	Anello Porta Guarnizione Posteriore	Rear Packing Retainer	Ø22	3	
19	3605 0134	Vite	Screw		3	
20	1210 0473	Guarnizione OR	O-Ring	Ø1,78x9,25	3	
21	0202 0143	Pistone	Piston	Ø22	3	
22	2812 0137	Rondella	Washer		3	
23	0202 0080	Boccola	Bushes		3	
24	2409 0272	Pistone Guida	Piston Guides		3	
25	3011 0041	Spinotto	Gudgeon Pin		3	
26	3020 0010	Seeger Interno	Inner Seeger	Ø20	6	
27	3018 0020	Spina	Pin	Ø4x8 H8	6	
28	2807 0021	Rondella	Washer	M10	6	
29	3609 0285	Vite	Screw	M10x40	6	
30	0201 0010	Boccola	Bushes		3	
31	3201 0032	Tappo Livello Olio	Oil Level Plug	G3/4"	1	
32	1602 0074	Linguetta	Key	12x8x70	1	
33	1210 0701	Guarnizione OR	O-Ring	Ø3x120	1	
34	0440 0045	Cuscinetto	Bearing	Ø50x110x29,25	1	
35	1009 0389	Flangia	Flange		1	
36	3609 0006	Vite	Screw	M8x30	8	
37	0001 0969	Albero Passante	Throughshaft	Ø40	1	
38	3609 0068	Vite	Screw	M6x12	4	
39	3200 0201	Tappo	Plug	G3/4"	1	
40	0402 0491	Coperchio Carter	Crankcase Cover		1	
41	3201 0032	Tappo Livello Olio	Oil Level Plug	G3/4"	1	
42	3200 0384	Tappo	Plug	G3/4"	1	
43	3609 0006	Vite	Screw	M8x30	8	
44	2404 0209	Piastra	Plate		1	
45	0403 0350	Carter Pompa	Pump Crankcase		1	
46	1209 0099	Guarnizione	Packing	G3/8"	3	
47	3200 0146	Tappo	Plug	G3/8"	3	
48	0402 0526	Coperchio Inferiore	Inferior Cover		1	
49	3201 0032	Tappo Livello Olio	Oil Level Plug	G3/4"	1	
50	0019 0137	Anello Tenuta	Packing	Ø35x52x7	3	
51	0402 0525	Coperchio Superiore	Upper Cover		1	
52	3020 0044	Seeger Interno	Inner Seeger	Ø52	3	
53	0601 0789	Distanziale	Spacer		1	
54	0440 0045	Cuscinetto	Bearing	Ø50x110x29,25	1	

N°	Cod.	Descrizione	Description	Note	Q.ty	Model
55	1210 0701	Guarnizione OR	O-Ring	Ø3x120	1	
56	0601 0756	Distanziale	Spacer	0,05	1	
56	0601 0757	Distanziale	Spacer	0,1	1	
56	0601 0758	Distanziale	Spacer	0,19	1	
56	0601 0759	Distanziale	Spacer	0,25	1	
57	1009 0388	Flangia	Flange		1	
58	3609 0006	Vite	Screw	M8x30	8	
59	0019 0187	Anello Tenuta	Packing	Ø50x65x8	1	
65	0205 0098	Kit Biella	Con. Rod Kit		1	

#### Kit Manutenzione

#### Maintenance Kit

**NB: Quantità necessaria per riparare una pompa**

**NB: Necessary quantity to repair one pump** 

N°	Cod.	Descrizione	Description	Note	Q.ty	Model
90	2409 0288	Kit Pistone	Piston Kit	Ø22	3	
91	5019 0243	Kit Guarnizioni Acqua Valvole	Valve Water Seal Kit		3	
92	5019 0276	Kit Guarnizioni Olio	Oil Seal Kit		1	
93	5019 0280	Kit Guarnizioni Acqua	Water Seal Kit		3	
94	5025 0070	Kit Valvole	Valve Kit		3	